

Betriebsdruck: max. 20 bar
 Betriebstemperatur: max. 175 °C
 Innengewinde: Rp-Gewinde nach ISO 7-1
 Außengewinde: R-Gewinde nach ISO 7-1

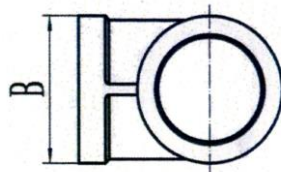
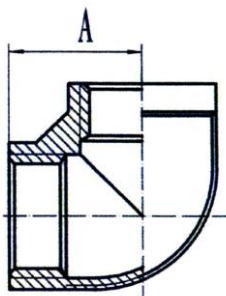

253.13-ES

Winkelstücke 90°, innen/innen, Rp-Gewinde nach ISO 7-1

Artikel Nr.	Ident Nr.	Gewinde	A mm	B mm
253.11-ES	112666	Rp 1/8	16,4	16,4
253.12-ES	112667	Rp 1/4	19,2	20,0
253.13-ES	112668	Rp 3/8	22,5	23,5
253.21-ES	112669	Rp 1/2	27,4	27,4
253.22-ES	112670	Rp 3/4	31,1	32,2
253.23-ES	112671	Rp 1	36,9	40,0

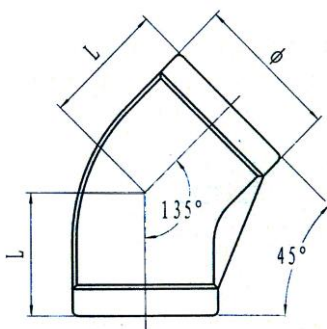

253.46-ES

Winkelstücke 45°, innen/innen, Rp-Gewinde nach ISO 7-1

Artikel Nr.	Ident Nr.	Gewinde	L mm	Ø mm
253.41-ES	112672	Rp 1/8	15,6	16,5
253.42-ES	112673	Rp 1/4	15,9	19,9
253.43-ES	112674	Rp 3/8	17,6	23,5
253.44-ES	112675	Rp 1/2	19,2	27,6
253.45-ES	112676	Rp 3/4	22,8	32,5
253.46-ES	112677	Rp 1	26,7	40,0

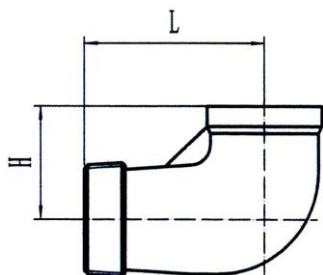

253.18-ES

Winkelstücke 90°, innen/außen, IG: Rp-Gewinde nach ISO 7-1, AG: R-Gewinde nach ISO 7-1

Artikel Nr.	Ident Nr.	Gewinde innen	Gewinde außen	H mm	L mm
253.15-ES	112678	Rp 1/8	R 1/8	17,0	24,0
253.16-ES	112679	Rp 1/4	R 1/4	20,0	28,0
253.17-ES	112680	Rp 3/8	R 3/8	22,0	32,0
253.18-ES	112681	Rp 1/2	R 1/2	27,0	38,0
253.19-ES	112682	Rp 3/4	R 3/4	32,0	45,0
253.20-ES	112683	Rp 1	R 1	37,0	52,0

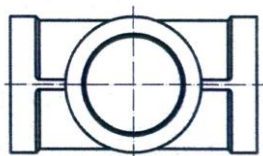
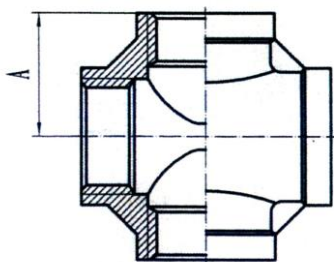

253.66-ES

Kreuzverteiler, 4 x innen, Rp-Gewinde nach ISO 7-1

Artikel Nr.	Ident Nr.	Gewinde	A mm
253.61-ES	112684	Rp 1/8	19,0
253.62-ES	112685	Rp 1/4	19,0
253.63-ES	112686	Rp 3/8	23,0
253.64-ES	112687	Rp 1/2	27,0
253.65-ES	112688	Rp 3/4	32,0

253.66-ES	112689	Rp 1	38,0
-----------	--------	------	------

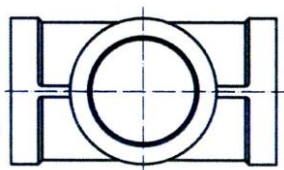
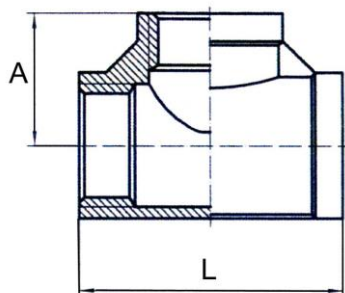

254.36-ES

T-Verteiler, 3 x innen, Rp-Gewinde nach ISO 7-1

Artikel Nr.	Ident Nr.	Gewinde	L mm	A mm
254.33-ES	112690	Rp 1/8	34,0	17,0
254.34-ES	112691	Rp 1/4	38,0	19,0
254.35-ES	112692	Rp 3/8	46,1	22,0
254.36-ES	112693	Rp 1/2	54,0	27,0
254.37-ES	112694	Rp 3/4	63,0	32,0
254.38-ES	112695	Rp 1	73,0	36,0